

Operating Instructions

IMPORTANT

These instructions should be read carefully and retained for future use.

Note also the information presented on the appliance.

Quantum Heater

Models:	QM070	QM100	QM125	QM150
Boost Output 230/240V~:	567/630W	792/880W	1017/1130W	1242/1380W
Storage Element Rating 230/240V~:	1435/1560W	2042/2220W	2540/2760W	3024/3300W
Rated Charge Period:	7.7 - 7 Hours			
Energy Cells:	18	24	30	36
Installed Weight:	91kg	115kg	142kg	165kg
kWh:	10.9kWh	15.5kWh	19.3kWh	23.1kWh

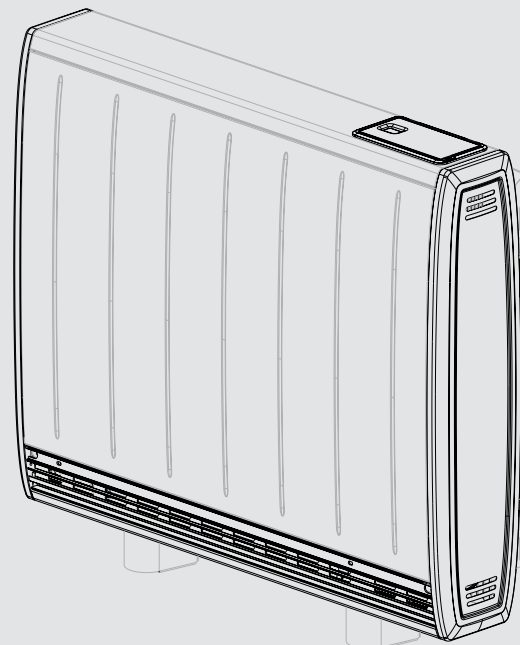

IMPORTANT

These instructions should be read carefully and retained for future use.

Note also the information presented on the appliance.

IMPORTANT

WARNING - THE SURFACE OF THIS HEATER CAN BE HOT.

- The surface temperatures of this heater are within the requirements of EN60335-2-61, the European Standard covering the safety requirements for Electric Storage Heaters, and momentary contact with any part of the heater should not cause injury. However, in order to be effective, heaters of any type do get hot, especially around the air outlet grille.
- If the supply cord is damaged, it must be replaced by a qualified individual in order to avoid a hazard.
- This appliance can be used by children aged from 8 years and above and persons with reduced physical, sensory or mental capabilities or lack of experience and knowledge if they have been given supervision or instruction concerning use of the appliance in a safe way and understand the hazards involved. Children must not play with the appliance. Cleaning and user maintenance must not be made by children without supervision.
- Children of less than 3 years should be kept away unless continuously supervised. Children aged from 3 years and less than 8 years shall only switch on/off the appliance provided that it has been placed or installed in its intended normal operating position and they have been given supervision or instruction concerning use of the appliance in a safe way and understand the hazards involved. Children aged from 3 years and less than 8 years must not plug in, regulate and clean the appliance or perform user maintenance.

CAUTION — Some parts of this product can become very hot and cause burns. Particular attention has to be given where children and vulnerable people are present.

- If aged or infirm persons, or young children, are likely to be left unsupervised in the vicinity of a heater precautions should be taken to ensure that prolonged contact with the heater cannot occur. Where particularly vulnerable people are likely to be left unsupervised in the vicinity of the heater we recommend that a guard is fitted around the heater, as is normal with heating appliances in similar circumstances. A range of guards specially designed for Dimplex heaters is available. If you require further information on these guards, please see contact details on back page of these instructions.

CAUTION: DO NOT COVER SURFACES OF THE HEATER AND DO NOT OBSTRUCT AIR OUTLET GRILLES.

- Surfaces of the heater should not be covered or obstructed as this can cause excessive temperatures that can be hazardous and may cause safety cut-outs to operate. This will stop the heater from working.
- Do not put clothes, fabrics or any combustible materials on the heater.
- Do not allow objects to come within 250mm (10") of the top and 75mm (3") of the ends of the heater. Do not allow any obstruction to be placed on the floor within 300mm (12") of the front of the heater and 75mm (3") of each side.
- Curtains must not come to within 75mm (3") of the top of the heater.
- DO NOT SIT OR STAND ON THE HEATER.
- DO NOT PLACE OBJECTS IN CONTACT WITH THE HEATER.
- IMPORTANT - Due to the newness of materials the heater will produce a smell for the first few days of operation. Rooms must be well ventilated and young children, caged birds, or persons with respiratory complaints must not remain in close proximity to the heater during the first 48 hours of operation.

PLEASE NOTE: YOUR HEATER IS VERY HEAVY AND MUST BE SECURELY FIXED TO A SOUND WALL.

- No attempt should be made to move the heater without first seeking specialist advice. If you are not happy that the heater has been securely fixed, please inform your installer.

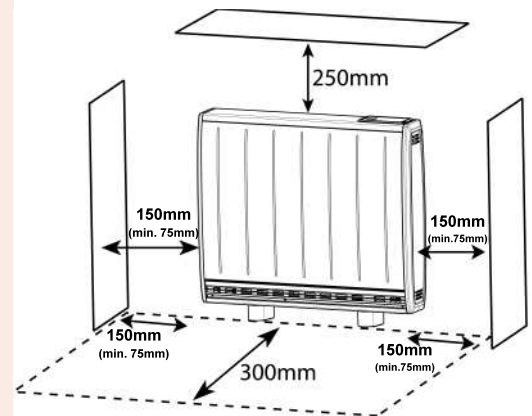

Do not place objects within 300mm of the front of the heater and 150mm (min. 75mm) either side.



**ATTENTION:
IN ORDER TO AVOID
OVERHEATING DO NOT
COVER THE HEATER**

The benefits of Quantum

Quantum is designed to be a responsive heating system that meets your comfort requirements while optimising energy use.

The heater releases heat in two ways:

1. A small amount of heat is dispersed by 'natural' convection and radiation from the heater case.
2. The vast majority of heat is released using the built-in fan that pushes hot air out from the heat outlet grille at the bottom of the product.

Minimising the release of stored heat from the outer casing means that more energy is available when warmth is required. This makes more efficient use of the stored energy as you can 'turn off' the heater when you are out or do not need it.

Heater Commissioning

IMPORTANT - The new materials in the heater will produce a slight smell for the first few days of operation.

Rooms must be well ventilated and young children, caged birds, or persons with respiratory complaints must not remain in close proximity to the heater during the first 48 hours of operation.

During first operation of the fan you may notice a small amount of dust discharged from the air outlet grille at the bottom of the product.

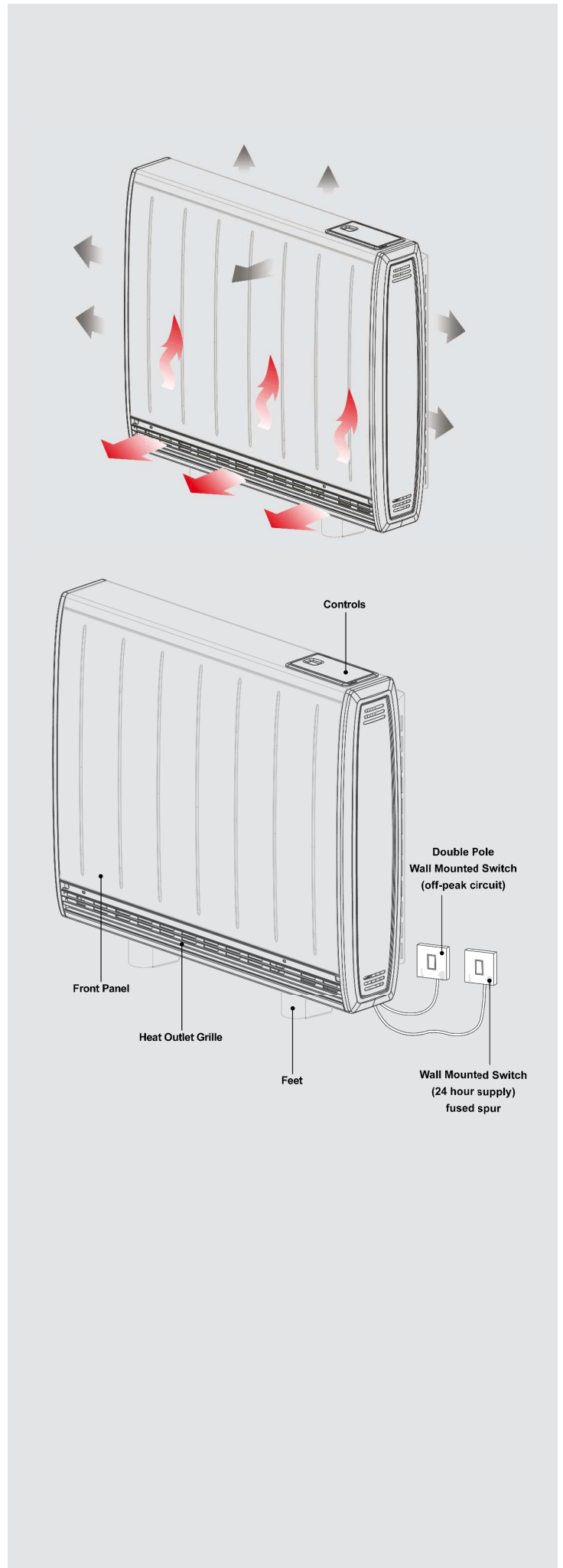

NOTE

DUE TO THE LOW ENERGY LOSSES FROM THE CASING OF THE HEATER THE SURFACE TEMPERATURE MAY APPEAR TO BE LOW, BUT THIS IS NORMAL.

NOTE

OCCASIONAL CLICKING SOUNDS DURING OPERATION ARE DUE TO TEMPERATURE CHANGES IN THE STORAGE CORE.

Function

Compared with traditional storage heaters the amount of energy released from the outer case of the heater is significantly reduced, resulting in lower surface temperatures. This allows more efficient running because the Quantum is heating the room only when you want it to.

The stored energy is primarily released by using a low speed fan to 'push' the heat from the stored core and into the room. Running the timed programs or adjusting the temperature thermostat will prompt the heater to run the fan automatically if it is required.

NOTE: THERE IS A DELAY OF UP TO TWO MINUTES ON THE FAN OPERATION WHEN SWITCHING TO 'Comfort On' AND 'Comfort Off', THIS IS NORMAL.

Summer

When heat is not needed both wall switches may be turned off. **Turn these both back on when heat is needed again in autumn, all of your previously stored settings and programmes will be remembered by the the heater.**

Operation

The user controls are located on the top right of the heater.

The heater is fitted with an adjustable electronic temperature controller and three buttons.

Programmable timer

- ① Display screen
- ② 'Menu' button
- ③ 'Back' button
- ④ Comfort status
- ⑤ 'Selector Dial'
- ⑥ 'Advance' button

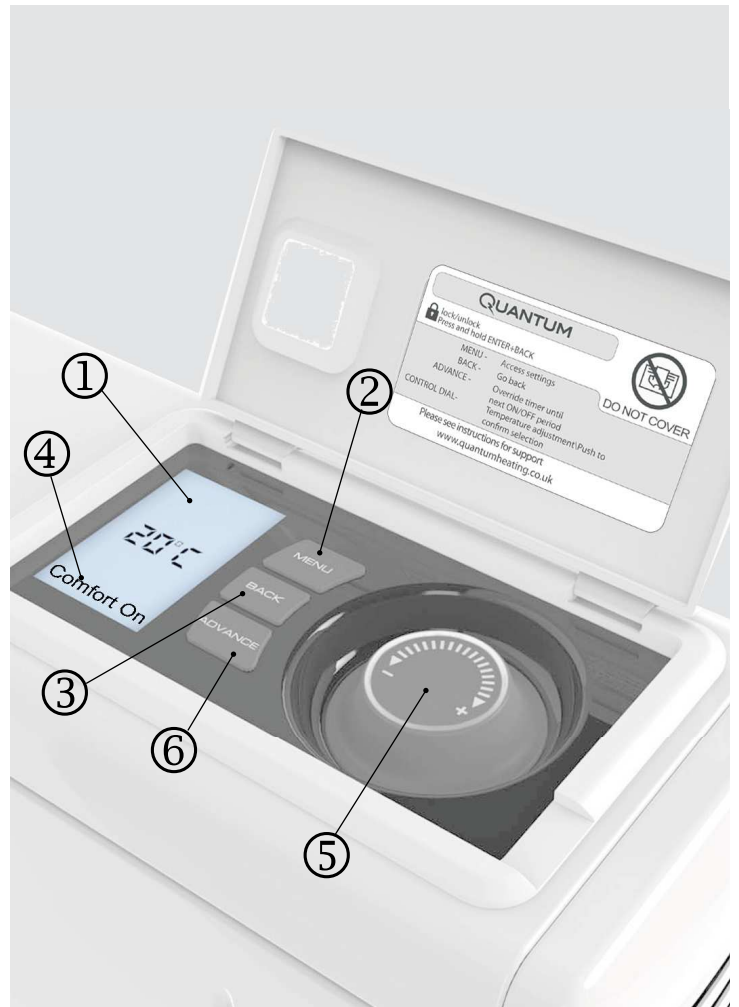

The **minimum** room temperature setting is 14°C.

The **maximum** temperature setting available is 26°C.

A temperature of approximately 20°C represents a **normal** room temperature.

It is normal for the fan to stop running for periods of time.

This happens because the room temperature is at or above the temperature set on the control and the room does not need more heat at this time.

Control Functions

The heater controls can easily be adjusted by using a combination of the three buttons and the selector dial, which can be rotated and pressed.

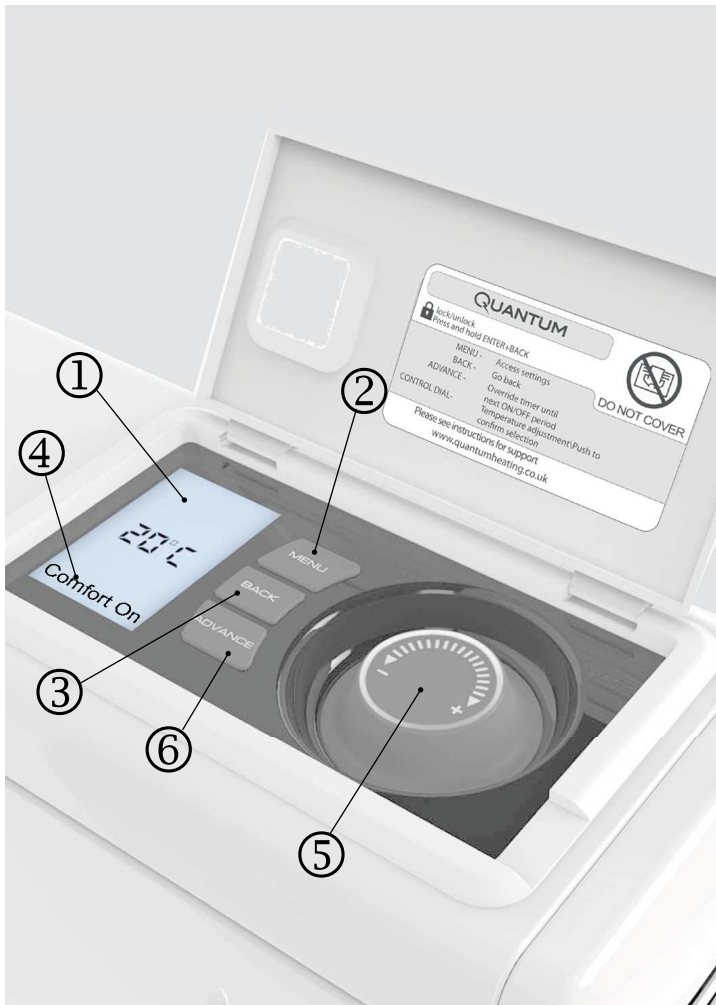

1. The **DISPLAY SCREEN** shows the options available at each stage of the adjustment.

2. **MENU** displays the main options list;

Date / Time - Setting today's date / time.

Timer Mode - Setting the timer to your individual requirements.

Boost - Selecting boost element operation.

Options - Temperature units and '**Daylight Saving**' settings.

3. **BACK** shows previous programming stage.

4. The periods during which the heater is providing heat are defined as '**Comfort On**' (this is shown at the bottom of the screen). Outside of these periods the heater will not deliver heat and these periods are called '**Comfort Off**'. During the '**Comfort On**' periods the low speed fan will run. During the '**Comfort Off**' periods the fan will not run.

If the heater is '**Comfort Off**' and heat is required, press the **ADVANCE** button. If the heater is '**Comfort On**' and heat is not required, press the **ADVANCE** button and it will go off until the beginning of the next '**Comfort On**' period.

5. **SELECTOR DIAL** can be turned clockwise and anti-clockwise and enables the required room temperature to be adjusted. The screen colour changes for warmer and cooler settings, showing deep blue through to bright red.

To check what setting the heater is currently using press the **Selector Dial** once and the timer mode will be displayed e.g. '**Out All Day**'.

6. **ADVANCE** overrides the time settings and changes the operational state of the fan, which will remain ON until the next OFF period is due, or OFF until the next ON period is due.

The **Selector Dial** is also used within the menu options to select and confirm your settings.

Setting the Date and Time

Your Quantum controller incorporates a real time clock with calendar function. The time clock has a battery backup that will keep the clock running in the event of a mains power outage.

To adjust the time or date follow the steps below.

Note - the display screen will return to standard display after a period of 20 seconds of inactivity.

Press the **Menu** button (1).

Select **Date / Time** by pressing the **Selector Dial** (2).

Rotate **Selector Dial**  to select the correct 'day' and press centre of dial to select.

Rotate **Selector Dial** to select the correct 'day of the month' and press centre of dial to select. Repeat this operation, rotating and pressing the dial, until date and time have been set, ensuring to press the dial to select. Press **Back** button to return to the **Main Screen**.

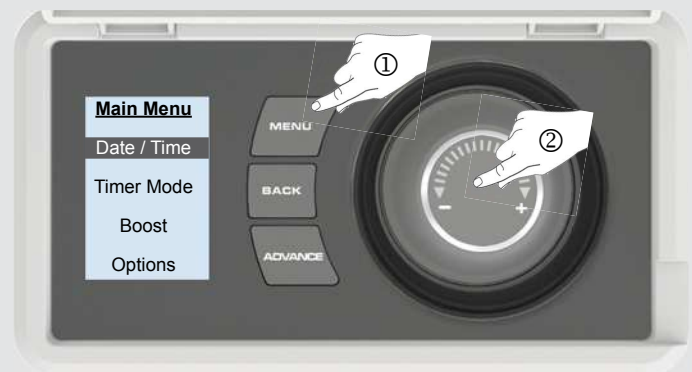

Choosing and Setting a Timer Mode

Your Quantum controller comes pre-programmed with a set of heating profiles.

There are four options available - three preset and one user adjustable timer;

1. **Out All Day** (pre-programmed) - has the following preset times Monday to Sunday, which can be altered if desired;

06.00 until 08.30

17.00 until 22.00

2. **Home All Day** (pre-programmed) - has the following preset times Monday to Sunday, which can be altered if desired;

06.30 until 09.30

11.00 until 13.00

15.00 until 17.00

18.00 until 22.00

3. **Holiday** (pre-programmed for 13 days at 10°C) - set the number of days required (from 1 to 255) and the temperature required. 7°C is advised if you just want to protect the property from frost while you are away.

4. **User Timer** - provides greatest flexibility to the user. Four time slots are available throughout the day and these can be customised for each day of the week.

To choose a Timer Mode press **Menu** and rotate the **Selector Dial** to select 'Timer Mode' and press **Selector Dial**.

Select the mode required, again by rotating and pressing the **Selector Dial**.

For options **Out All Day**, **Home All Day** and **User Timer**, three choices are available - **Select**, **Preview** and **Modify**.

Select - choose this timer option.

Preview - view the times currently set.

Modify - change the times currently set.

When **Modify** is chosen, select and change each option by rotating and pressing the **Selector Dial**. When a day is complete select **Save** to update it.

Once the first day has been set up it is possible to copy these settings to successive days or all days by again choosing **Modify**, selecting the day with the correct settings and either choosing **Copy next** or **Copy all**.

If preferred each day can be modified individually and saved. It is also possible to **Clear** each day or **Clear all** days. Options are;

Save - save times for one day.

Copy next - copy times to following day.

Copy all - copy times to all seven days.

Clear - zero all times that day.

Clear all - zero times for all seven days.

To select **Mode**, choose **Select** and press **Selector Dial**.

NOTE ONCE MODIFIED A PROGRAMME MUST BE SELECTED IF YOU WANT TO BEGIN USING IT.



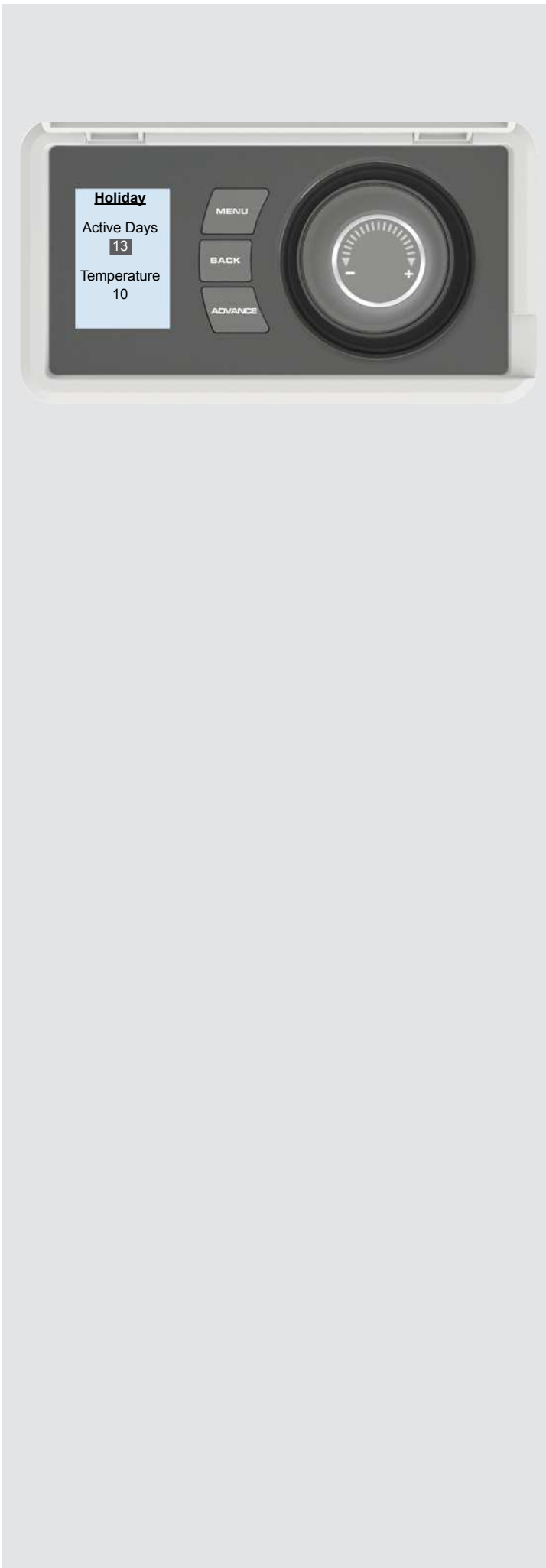

In **Holiday** mode the number of days that the room will be unoccupied can be adjusted together with the required room temperature.

Rotate the **Selector Dial** to choose a holiday period between 1 and 255 days, then press the **Selector Dial**.

Rotate the **Selector Dial** to choose a temperature between 7°C (frost protection) and 26°C (comfort) to be maintained during this period and press the **Selector Dial**. At the end of the holiday mode the heater will automatically revert back to the previously selected programme.

Main Screen

After 10 seconds the heater will default back to the **Main Screen**. Here the chosen temperature is displayed along with **Comfort On** or **Comfort Off**, which tells you whether you are in a timed heating period or not. Any use of the **Advance** function will be displayed here, and pressing the **Selector Dial** will show the **Timer Mode** in use.

When left inactive for a long period of time this display will 'sleep' and the text will disappear. Press the **Selector Dial** for its return.

Boost

A supplemental heating (boost) element controlled by the electronic thermostat is provided for occasions when a brief increase in heating is required. This will operate only by selecting '**Menu**', then '**Boost**' and then selecting a boost period of 1 hour, 2 hours, 3 hours, 4 hours or Auto Boost.

Note: The boost element will only activate if the level of stored energy is less than 50% of the full charge.

Use this function only if you require a room temperature that is greater than what can be achieved using the stored energy alone.

'**Boost on**' will be displayed on the home screen when boost is selected.

Auto Boost allows the heater to use the boost element to maintain the selected temperature automatically. This ensures that the temperature is correct if ever the core is depleted, but will increase the running cost of the heater.



Options

The **Options** menu enables you to choose time and temperature formats to suit your preferences. These are;

DST Rule - Select your daylight saving setting.

The heater clock will automatically adjust for daylight saving (British Summer Time as it is often referred to). If no adjustment is required then select none.

Temp Units - Choose whether your unit displays degrees centigrade or fahrenheit.

Child Lock

To lock the controls press **Back** and the **Selector Dial** together for three seconds. **Child Lock** will appear at the bottom of the screen. To unlock the control repeat the action of pressing **Back** and **Selector Dial** for three seconds.

Note - The controls cannot be adjusted when child lock is active.

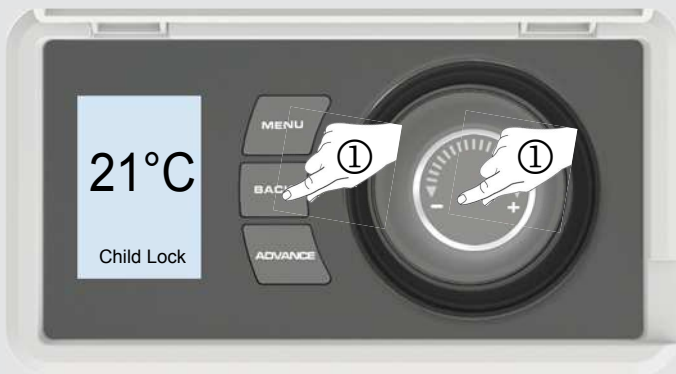
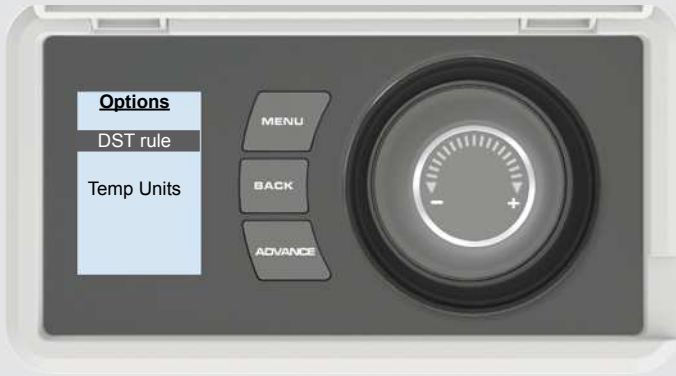

User Information

Press and hold the **Selector Dial** to display the **User Information** menu, three choices are available;

SP Range - enables adjustment of the temperature range available. Maximum range 7°C to 30°C.

Factory - return all settings to the factory presets - **Yes** or **No**.

Extra Charge - forces an extra charge of up to four hours during off-peak periods.

If the output of the heater is not able to deliver the required comfort level then it is possible to force the heater to store additional energy. In this way more electrical energy is stored during the off-peak period and this will increase comfort levels. Up to four hours additional off-peak charging can be selected.

NOTE: The extra charge option will lead to more energy being stored during the off peak period, this will lead to higher running costs. Only use this setting when a room is consistently below the required temperature and you are sure that the timer mode is set up and selected correctly.

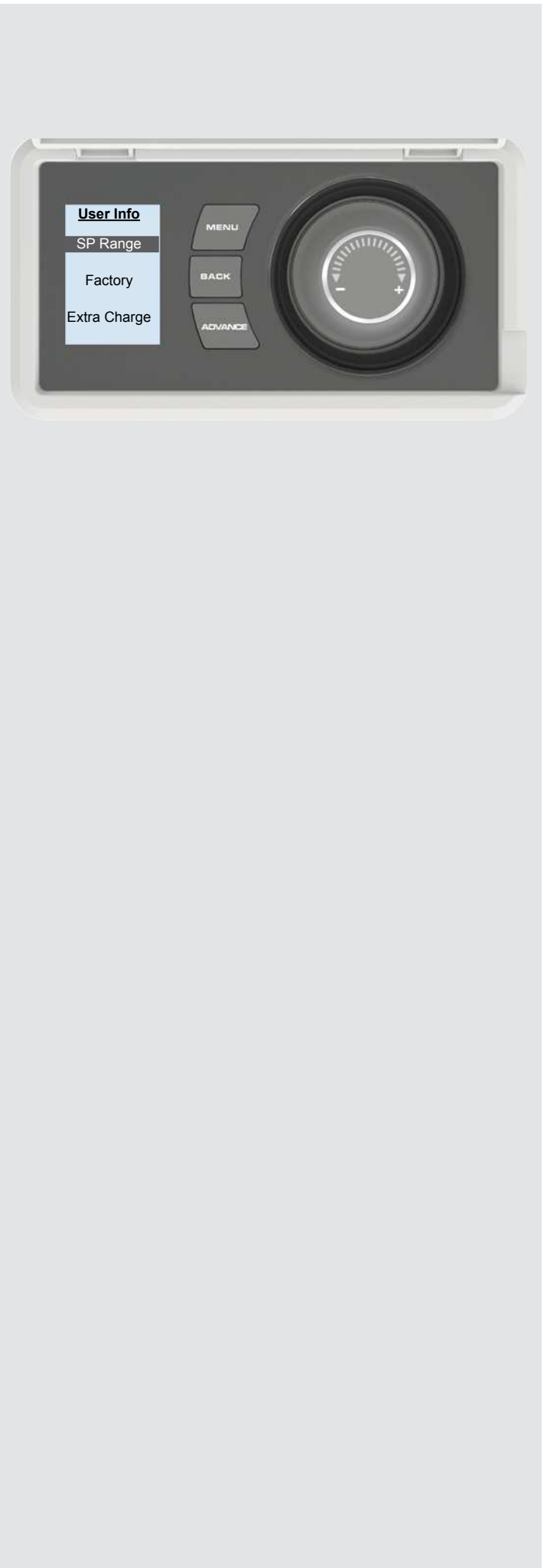

Important

During the initial operation some odour may be noticed due to the newness of materials used in manufacture. This is normal and will disappear after a short period of use. It is however advisable to keep the room well ventilated.

ROOMS MUST BE WELL VENTILATED AND YOUNG CHILDREN, CAGED BIRDS, OR PERSONS WITH RESPIRATORY COMPLAINTS MUST NOT REMAIN IN CLOSE PROXIMITY TO THE HEATER DURING THE FIRST 48 HOURS OF OPERATION.

Cleaning

To maintain the external appearance of the heater it need only be wiped over occasionally with a dry duster. During the summer months, or at other times when the appliance is not in use and is completely cold, the opportunity should be taken to wipe over with a damp cloth. Do not use abrasive cleaning powders or furniture polish.

Discolouration of wall finishes can sometimes occur immediately above a heater due to the properties of some paints and decorating materials or the presence of environmental impurities in the air (such as soot or incense generated from the burning of candles, etc.). A suitable shelf (available from Dimplex) may be fitted to limit the extent of any wall discolouration.

After Sale Service

If this product appears damaged when first received or does not function correctly contact us by e-mail at aftersales@dimplex.co.uk or call 0844 879 35 88 and we will be able to help. For ROI please call 01 842 4833.

Do not return the product in the first instance as this may delay us providing you with a satisfactory service.

ACCIDENTAL DAMAGE IS NOT COVERED UNDER THE WARRANTY.

Your product is guaranteed for two years from the date of purchase. Within this period, we undertake to repair this product free of charge provided it has been installed and operated in accordance with these instructions.

Should you require assistance with this product please go to www.dimplex.co.uk and click on "Customer Support" or e-mail us at aftersales@dimplex.co.uk

Alternatively call our contact centre on 0844 879 35 88 (UK only). This is a Lo-call number from a BT landline - other providers including mobile phones may charge you more. For ROI please call 01 842 4833.

To assist you, we will need the following information: model number and serial number (these can be found on the product, on the top right hand side of the rear heat shield, directly behind the control cover), nature of the fault and date of purchase. **Please retain your receipt as proof of purchase.** Your rights under this guarantee are additional to your statutory rights, which in turn are not affected by this guarantee.

Spares can be purchased on line, go to www.dimplex.co.uk/outlet_store

Heater Guards

A range of protective guards are available to fit the Quantum heater. They ensure contact with hot surfaces is avoided and prevent tampering with the product. For more information please contact;

Aiano Ltd. - Tel: 020 7987 1184, Web: www.aianos.co.uk

Co-ordinated Heating

Dimplex manufactures a complete range of heating appliances, to provide co-ordinated heating throughout the home or office. Visit our website or contact us on the details above for more information on how we can help with your heating requirements.

Recycling



For electrical products sold within the European Community. At the end of the electrical products useful life it should not be disposed of with household waste. Please recycle where facilities exist. Check with your Local Authority or retailer for recycling advice in your country.

CE This product complies with the European Safety Standards EN60335-2-30 and the European Standard Electromagnetic Compatibility (EMC) EN55014, EN60555-2 and EN60555-3. These cover the essential requirements of EEC Directives 2006/95/EC and 2004/108/EC

Dimplex
A world of expertise

Dimplex, Millbrook House, Grange Drive, Hedge End, Southampton SO30 2DF
Customer Help Line: 0844 879 3588 Fax: 0844 879 3583
Email: aftersales@dimplex.co.uk Website: www.dimplex.co.uk